

BINKS® MODEL 2100™ SPRAY GUN
2101-XXXX-X

Your new Binks spray gun is exceptionally rugged in construction, and is built to stand up under hard, continuous use. However, like any other fine precision instrument, its most efficient operation depends on a knowledge of its construction, operation, and maintenance. Properly handled and cared for, it will produce beautiful, uniform finishing results long after other spray guns have worn out.

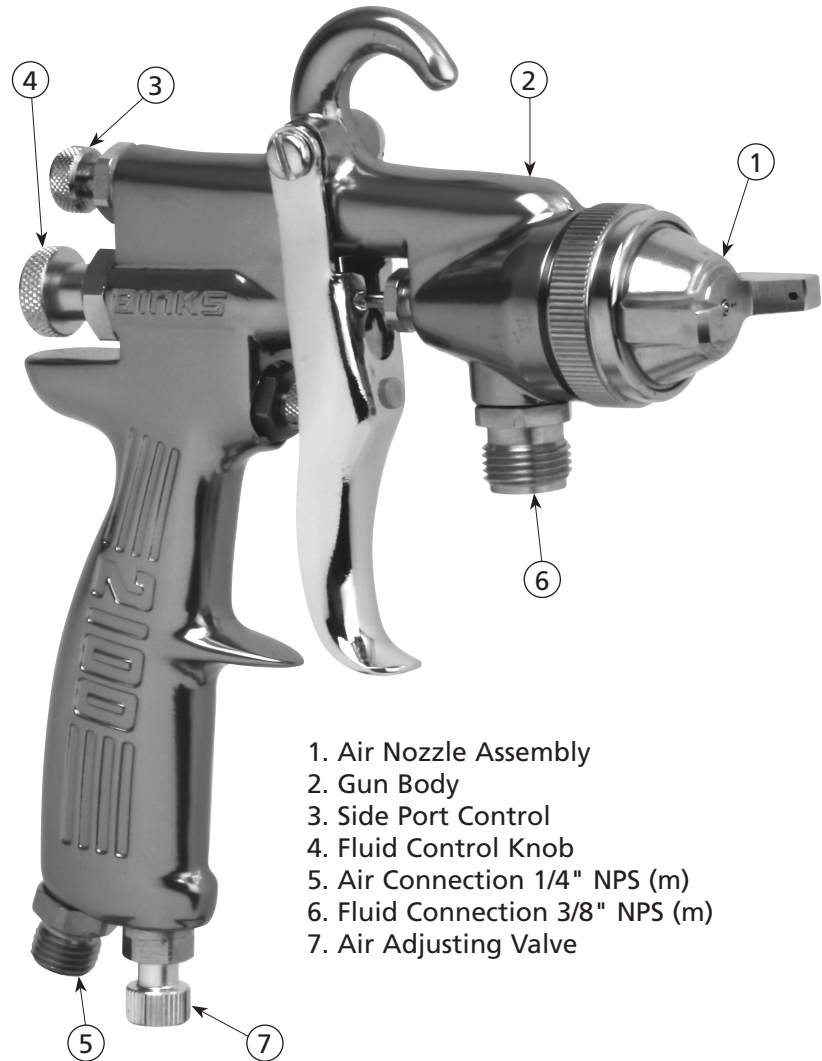

- 1. Air Nozzle Assembly
- 2. Gun Body
- 3. Side Port Control
- 4. Fluid Control Knob
- 5. Air Connection 1/4" NPS (m)
- 6. Fluid Connection 3/8" NPS (m)
- 7. Air Adjusting Valve

IMPORTANT!
DO NOT DESTROY

It is the customer's responsibility to have all operators and service personnel read and understand this manual.

Contact your local Binks representative for additional copies of this manual.

SPECIFICATIONS

Maximum Air Pressure	100 psi / 6.9 bar
Maximum Fluid Pressure	100 psi / 6.9 bar
Gun Body	Anodized Aluminum
Fluid Path	Stainless Steel
Fluid Inlet Size	3/8" NPS
Air Inlet Size	1/4" NPS
Gun Weight	1 lb 6 oz / 635 gm

READ ALL INSTRUCTIONS BEFORE OPERATING THIS BINKS PRODUCT.

In this part sheet, the words **WARNING**, **CAUTION** and **NOTE** are used to emphasize important safety information as follows:

⚠ WARNING
 Hazards or unsafe practices which could result in severe personal injury, death or substantial property damage.

⚠ CAUTION
 Hazards or unsafe practices which could result in minor personal injury, product or property damage.

NOTE
 Important installation, operation or maintenance information.

⚠ WARNING

Read the following warnings before using this equipment.



READ THE MANUAL
 Before operating finishing equipment, read and understand all safety, operation and maintenance information provided in the operation manual.



WEAR SAFETY GLASSES
 Failure to wear safety glasses with side shields could result in serious eye injury or blindness.

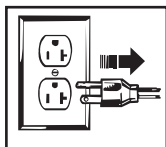

DE-ENERGIZE, DISCONNECT AND LOCK OUT ALL POWER SOURCES DURING MAINTENANCE
 Failure to De-energize, disconnect and lock out all power supplies before performing equipment maintenance could cause serious injury or death.



OPERATOR TRAINING
 All personnel must be trained before operating finishing equipment.



EQUIPMENT MISUSE HAZARD
 Equipment misuse can cause the equipment to rupture, malfunction, or start unexpectedly and result in serious injury.



KEEP EQUIPMENT GUARDS IN PLACE
 Do not operate the equipment if the safety devices have been removed.

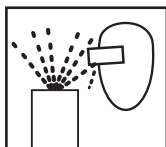

PROJECTILE HAZARD
 You may be injured by venting liquids or gases that are released under pressure, or flying debris.



PINCH POINT HAZARD
 Moving parts can crush and cut. Pinch points are basically any areas where there are moving parts.



AUTOMATIC EQUIPMENT
 Automatic equipment may start suddenly without warning.



INSPECT THE EQUIPMENT DAILY
 Inspect the equipment for worn or broken parts on a daily basis. Do not operate the equipment if you are uncertain about its condition.



NEVER MODIFY THE EQUIPMENT
 Do not modify the equipment unless the manufacturer provides written approval.



KNOW WHERE AND HOW TO SHUT OFF THE EQUIPMENT IN CASE OF AN EMERGENCY



PRESSURE RELIEF PROCEDURE
 Always follow the pressure relief procedure in the equipment instruction manual.



NOISE HAZARD
 You may be injured by loud noise. Hearing protection may be required when using this equipment.



STATIC CHARGE
 Fluid may develop a static charge that must be dissipated through proper grounding of the equipment, objects to be sprayed and all other electrically conductive objects in the dispensing area. Improper grounding or sparks can cause a hazardous condition and result in fire, explosion or electric shock and other serious injury.



FIRE AND EXPLOSION HAZARD
 Never use 1,1,1-trichloroethane, methylene chloride, other halogenated hydrocarbon solvents or fluids containing such solvents in equipment with aluminum wetted parts. Such use could result in a serious chemical reaction, with the possibility of explosion. Consult your fluid suppliers to ensure that the fluids being used are compatible with aluminum parts.

FOR FURTHER SAFETY INFORMATION REGARDING BINKS AND DEVILBISS EQUIPMENT, SEE THE GENERAL EQUIPMENT SAFETY BOOKLET (77-5300).

TYPES OF INSTALLATION

Air pressure for atomization is regulated at the extractor. The flow of the fluid is adjusted by the fluid valve control knob on gun, viscosity of paint and air pressure.

PRESSURE CUP HOOKUP (Figure 1)

For fine finishing with limited spraying. Air pressure for atomization is regulated at extractor; fluid pressure at cup regulator. Pressure cup is also available less regulator.

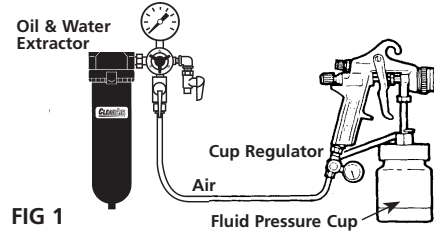

FIG 1

PRESSURE TANK HOOKUP (Figure 2)

For medium production spraying (single regulator). Air pressure for atomization is regulated at extractor, fluid pressure at tank regulator.

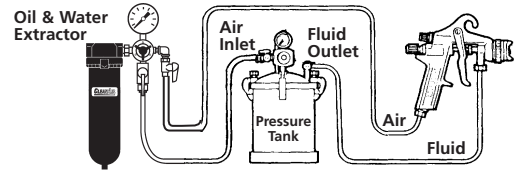

FIG 2

PRESSURE TANK WITH 2 REGULATORS (Figure 3)

The pressure to the tank is regulated by the first regulator. The pressure for atomization is regulated by the second regulator.

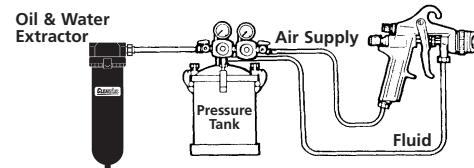

FIG 3

PRESSURE CIRCULATING HOOKUP (Figure 4)

For heavy production spraying. Air pressure atomization regulated at extractor. Fluid pressure regulated at fluid regulator.

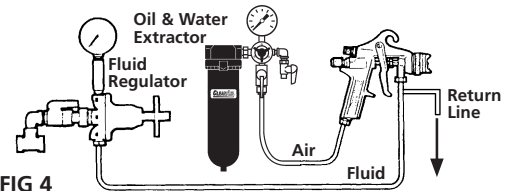

FIG 4

SIPHON FEED HOOKUP (Figure 5)

Air pressure for atomization is regulated at extractor. The amount of fluid is adjusted by fluid control screw on gun, viscosity of paint, and air pressure.

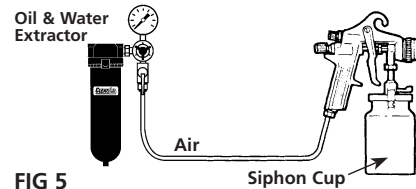

FIG 5

AIR PRESSURE

Atomizing pressure must be set properly to allow for the drop in air pressure between the regulator and the spray gun.

WITH 60 PSI APPLIED AT AIR SUPPLY

5/16"

RECOMMENDED
48 PSI at gun inlet

25 feet of 5/16" I.D. hose causes a drop of 12 PSI between the air supply and the gun. For this reason Binks recommends the use of 5/16" hose.

1/4"

NOT RECOMMENDED
Only 34 PSI at gun inlet

25 feet of 1/4" I.D. hose causes a drop of 26 PSI between the air supply and the gun.

An oil and water extractor is important.

Achieving a fine spray finish without the use of a good oil and water extractor is virtually impossible.

A regulator/extractor serves a double purpose. It eliminates blistering and spotting by keeping air free of oil and water, and it gives precise air pressure control at the gun.

Binks recommends using Model HFRL-508 Oil and Water Separator / Regulator. See your local distributor for other models.

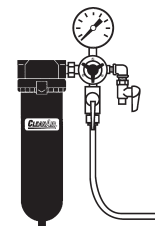

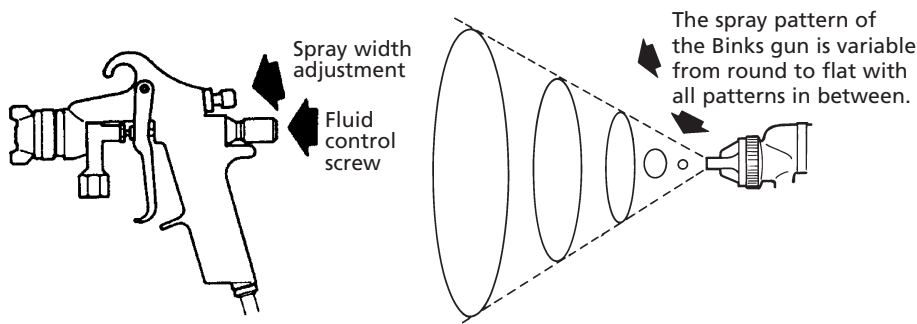

In normal operation, the wings on the nozzle are horizontal as illustrated here. This provides a vertical fan shaped pattern which gives maximum coverage as the gun is moved back and forth parallel to the surface being finished.

Spray width adjustment: Turn clockwise for round, counterclockwise for fan.

Fluid control screw: Turn clockwise to decrease flow, counterclockwise to increase flow.

As width of spray is increased, more material must be allowed to pass through the gun to obtain the same coverage on the increased area.

SIPHON SPRAYING

Set atomization pressure at approximately 50 PSI for lacquer and 60 PSI for enamel. Test spray. If the spray is too fine, reduce the air pressure or open fluid control screw. If the spray is too coarse, close the fluid control screw. Adjust the pattern width and repeat adjustment of spray if necessary.

PRESSURE SPRAYING

After selecting correct size fluid orifice, set fluid pressure for desired flow. Open atomization air and test spray. If spray is too fine, reduce air pressure. If spray is too coarse, raise air pressure. Adjust pattern width and repeat adjustment of spray. Keeping fluid control screw in open position will reduce fluid needle wear.

GUN HANDLING

The first requirement for a good resultant finish is the proper handling of the gun. The gun should be held perpendicular to the surface being covered and moved parallel with it. The stroke should be started before the trigger is pulled and the trigger should be released before the stroke is ended. This gives accurate control of the gun and material.

The distance between gun and surface should be 6 to 12 inches depending on material and atomizing pressure. The material deposited should always be even and wet. Lap each stroke over the preceding stroke to obtain a uniform finish.

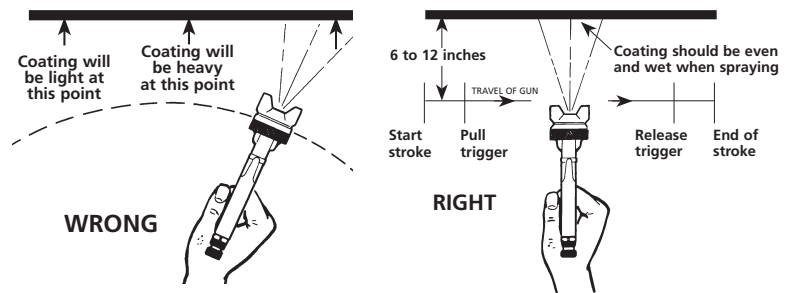

NOTE
To reduce overspray and obtain maximum efficiency, always spray with the lowest possible atomizing air pressure.

AIR SUPPLY



It is extremely poor practice to mount the oil and water extractor on or even near the compressor unit. The temperature of the air is greatly increased as it passes through the compressor and this compressed air must be cooled before the moisture in it will condense. If the air from the compressor is still warm when it passes through the oil and water extractor, moisture will not be effectively removed, but will remain in suspension. Then, when the air cools in the hose beyond the extractor, the moisture will condense into drops of water and cause trouble.

Air lines must be properly drained

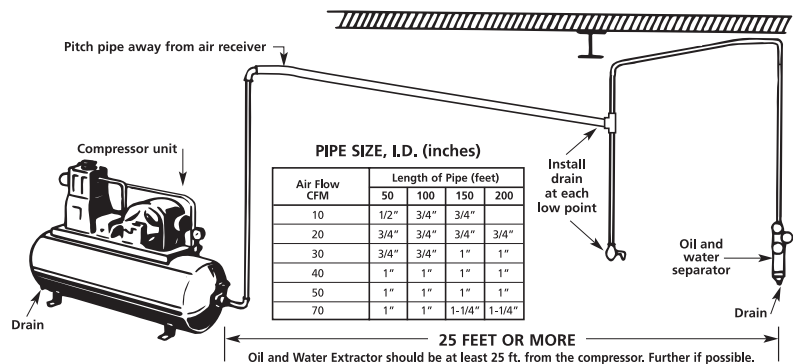
Pitch all air lines back towards the compressor so that condensed moisture will flow back into the air receiver where it can be removed by opening a drain. Every low point on an air line acts as a water trap. Such points should be fitted with an easily accessible drain. See diagram.

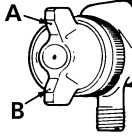
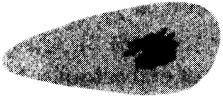
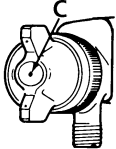

FAULTY PATTERNS AND HOW TO CORRECT THEM

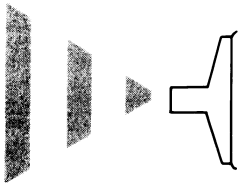
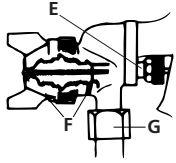
PATTERN	CAUSE	CORRECTION
	<p>Dried material in side-port "A" restricts passage of air. Greater flow of air from cleaner side-port "B" forces fan pattern in direction of clogged side.</p> 	<p>Dissolve material in side-ports with thinner, then blow gun clean. Do not poke into openings with metal instruments.</p>
	<p>Dried material around the outside of the fluid nozzle tip at position "C" restricts the passage of atomizing air at one point through the center opening of air nozzle and results in pattern shown. This pattern can also be caused by a loose air nozzle.</p> 	<p>Remove air nozzle and wipe off fluid tip using rag wet with thinner. Tighten air nozzle.</p>
	<p>A split spray or one that is heavy on each end of a fan pattern and weak in the middle is usually caused by:</p> <ol style="list-style-type: none"> (1) Too high an atomization air pressure (2) Attempting to get too wide a spray pattern with thin material. 	<p>Reducing air pressure will correct cause (1). To correct cause (2), open material control to full position by turning to left. At the same time, turn spray width adjustment to right. This will reduce width of spray, but will correct split spray pattern.</p>
	<ol style="list-style-type: none"> (1) Dried out packing around material needle valve permits air to get into fluid passageway. This results in spitting. (2) Dirt between fluid nozzle seat and body or loosely installed fluid nozzle will make gun spit. (3) A loose or defective swivel nut on siphon cup or material hose can cause spitting. 	 <p>To correct cause (1) back up knurled nut (E), place two drops of machine oil on packing, replace nut and tighten with fingers only. In aggravated cases, replace packing.</p> <p>To correct cause (2), remove fluid nozzle (F), clean back of nozzle and nozzle seat in gun body using rag wet with thinner, replace nozzle and draw up tightly against body.</p> <p>To correct cause (3), tighten or replace swivel nut.</p>

Binks MODEL 2100™ SIPHON SPRAY GUN

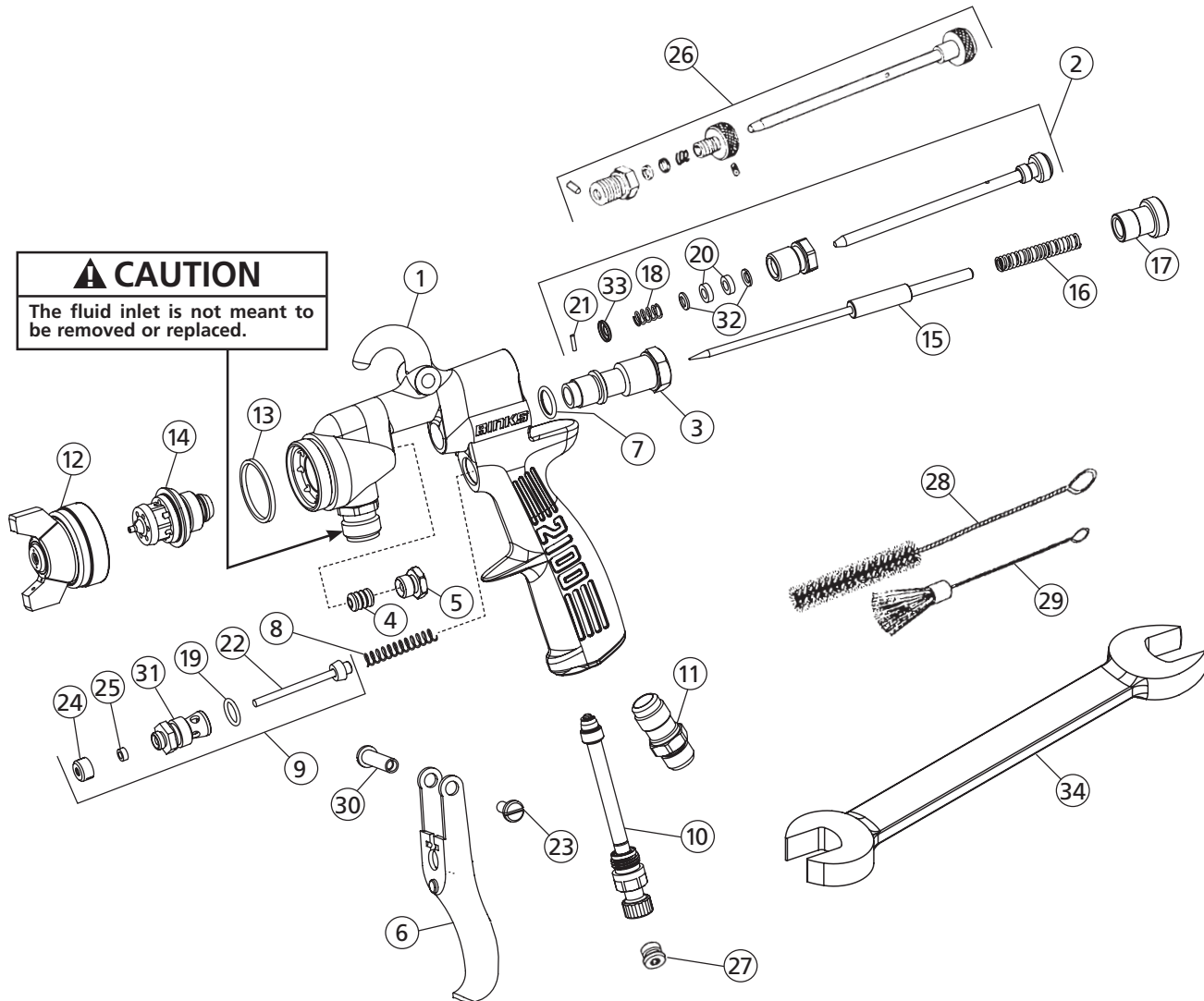

CAUTION
The fluid inlet is not meant to be removed or replaced.

PARTS LIST

When ordering, please specify Part No.

ITEM NO.	PART NO.	DESCRIPTION	QTY.	ITEM NO.	PART NO.	DESCRIPTION	QTY.
1	—	2100 GUN BODY (NOT SOLD SEPARATELY)	1	19	20-3757+	O-RING	1
2	54-3347	SIDE PORT CONTROL ASSEMBLY	1	20	54-738-5○+	PACKING	2
3	54-1013	MATERIAL BODY	1	21	54-1014-5○+	PIN	1
4	2-28-5○+*	PTFE PACKING	1	22	54-1025+	VALVE STEM ASSEMBLY	1
5	56-164	PACKING NUT	1	23	82-126-5○	SCREW	1
6	54-5464	2100 TRIGGER	1	24	82-135-5○	NUT	1
7	20-5285-5○+	O-RING VITON	1	25	82-158-5○+	PACKING	1
8	54-750-5○+	SPRING	1	26	54-1780•	QUICK CHANGE SIDEPORT CONTROL... (SOLD SEPARATELY AS ASSEMBLY)	1
9	54-1236	AIR VALVE ASSEMBLY	1	27	JGA-132•	PLUG (SOLD SEPARATELY)	1
10	SGK-457-K	AIR ADJUSTMENT VALVE	1	28	82-469	ROUND BRUSH	1
11	54-768	AIR CONNECTION	1	29	OMX-88	FLAT BRUSH	1
12	*SEE FOOTNOTE	AIR NOZZLE	1	30	54-1020	STUD	1
13	54-918-5○+	GASKET	1	31	54-1010	VALVE BODY	1
14	*SEE FOOTNOTE	FLUID NOZZLE	1	32	54-1016-5	WASHER	2
15	*SEE FOOTNOTE	FLUID NEEDLE	1	33	54-1015-5	WASHER	1
16	54-1347-5○+✓	SPRING	1	34	5-476	FLUID NOZZLE WRENCH	1
17	54-1007	CONTROL SCREW	1				
18	54-304-5○+	SPRING	1				

○ Available only as 5-Pack.

+ Indicates parts in 6-229 Repair Kit.

* Alternate needle packing (optional) 54-747-5.

• Accessory item.

✓ Also available: Heavy Duty Spring 54-1372, not furnished. Please order separately.

* Be sure to specify number stamped on air nozzle and fluid nozzle, or see Nozzle Selection Chart.

Binks MODEL 2100™ SIPHON SPRAY GUN – POINTERS ON CLEANING

When used with a cup, thinner or suitable solvent should be siphoned through gun by inserting tube in open container of that liquid. Move trigger constantly to thoroughly flush passageway and to clean tip of needle.

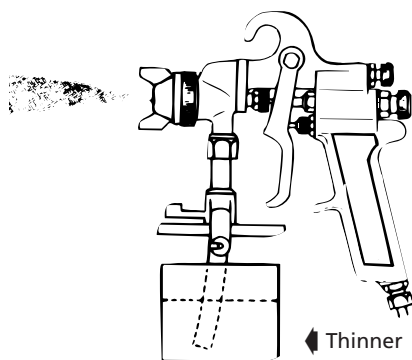

CLEANING GUN USED WITH PRESSURE TANK

Shut off the air supply to the tank and release the pressure on the tank. Open vent and loosen air nozzle. Hold a piece of cloth, wadded in the hand over the air nozzle and pull the trigger, the air will back up through the fluid nozzle, and force the fluid out of the hose into the tank. Next put enough thinner into the tank to wash the hose and gun thoroughly and spray this through the gun until it is clean. Then blow out the fluid hose to dry it and remove all traces of materials by attaching it to the air line.

THINNER

Keep thinner level below packing. It is extremely poor practice to place an entire gun in thinner. When this is done, the solvent dissolves the oil in the leather packing and causes the gun to spit. It is good practice to place the nozzle and fluid connection in thinner. Vessel used should be shallow enough to prevent thinner from reaching packing.

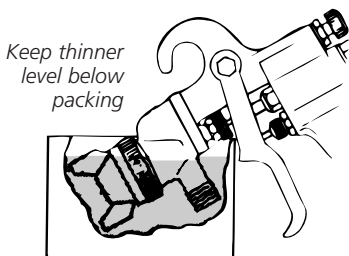

LUBRICATION

Daily oil fluid needle packing, air valve packing, and trigger bearing screw. Occasionally coat needle valve spring with petroleum jelly. **OIL ALL WORKING PARTS EVERY DAY.**

CONTROLLING THE FAN SPRAY: The fan spray for an external mix nozzle set-up is easily controlled by means of the side port control (2). Turning this control to the right, or clockwise, until it is closed will give a round spray; turning it to the left, or counter-clockwise, will widen the spray into a fan shape of any width desired. The direction of the fan spray, either horizontal or vertical, is obtained by turning the air nozzle to the desired position, then tightening the retainer ring.

CONTROLLING THE FLUID

If a fluid pressure tank is used, the amount of fluid can be controlled by regulating the pressure on the tank. The amount of fluid can also be controlled by means of the fluid control screw (17). Turning this screw to the right, or clockwise, reduces the amount of fluid; to the left, or counter-clockwise, increases the amount of fluid.

FAULTY SPRAY

A faulty spray is caused by improper cleaning or dried material around the fluid nozzle tip or in the air nozzle. Soak these parts in a solvent that will soften the dried material and remove with a brush or cloth.

CAUTION

Never use metal instruments to clean the air or fluid nozzles. These parts are carefully machined and any damage to them will cause a faulty spray.

If either the air nozzle or fluid nozzle is damaged, the part must be replaced before a perfect spray can be obtained.

TO REPLACE THE FLUID PACKING:

Remove the fluid control screw (17), spring (16) and needle. Then remove the fluid packing nut (5) and take out the old packings with a small stiff wire. Replace with new packings (4) oiled lightly and assemble in reverse order. To set packing, insert needle, tighten nut until the needle begins to be too stiff for the spring to move the needle. Then loosen nut 1/2 to 3/4 turn.

CORRECTING AIR LEAK THROUGH GUN

Air leaking through the gun is caused by the valve stem assembly (22), not seating properly against the valve body (31). Remove the valve body (31) and valve stem assembly (22). Thoroughly clean parts and inspect for damage. Replace worn or damaged parts and assemble in reverse order.

CORRECTING AIR LEAK AROUND AIR VALVE STEM

Air leaking around the air valve stem (22) may be caused by worn packings (25) or damaged air valve stem (22). Remove trigger (6), packing nut (24) and packings (25). Clean extended portion of air valve stem (22) and inspect for damage; if stem is damaged, replace same as above, insert new packings and assemble in reverse order.

Binks MODEL 2100™ SPRAY GUN – GENERAL MAINTENANCE

SPRAY GUN

1. Immerse only the front end of the gun until solvent just covers the fluid connection.
2. Use a bristle brush and solvent to wash off accumulated paint.
3. Do not submerge the entire spray gun in solvent because:
 - a. the lubricant on the packings will dissolve and the packings will dry out.
 - b. the lubricant at wear surfaces will dissolve causing harder operation and faster wear.
 - c. residue from dirty solvent may clog the narrow air passages in the gun.
4. Wipe down the outside of the gun with solvent-dampened rag.
5. Lubricate gun daily. Use a light machine oil on:
 - a. fluid needle packing.
 - b. air valve packing.
 - c. side port control packing.
 - d. trigger pivot point.
 Coat the fluid control spring with vaseline.

⚠ CAUTION

Never use lubricants containing silicone. This material may cause finish defects.

NOTE

All parts on a spray gun should be screwed in hand tight at first; this will avoid the possibility of cross threading the parts. If the parts can not be turned by hand easily, make sure you have the correct parts, unscrew, realign, and try again. NEVER use undue force in mating parts.

⚠ CAUTION

Never unscrew the fluid inlet nipple! (Item 6, front page.) It is not meant to be removed or replaced.

AIR NOZZLE, FLUID NOZZLE, FLUID NEEDLE

1. All nozzles and needles are precision made. They should be handled with care.
2. Do not make any alterations in the gun. To do so could cause finishing difficulties.
3. To clean nozzles, soak them in solvent to dissolve any dried material, then blow them clean with air.
4. Do not probe any of the holes in the nozzles with metal instruments. If probing is necessary, use only a tool that is softer than brass.

NOZZLE SELECTION

(See chart on pages 10-11)

A. Material to Be Sprayed

Select the type of fluid you want to spray or a fluid which has the same characteristics as one of those listed.

B. Method of Feeding Material to the Gun

Fluid Nozzle—Consider the speed of application and the viscosity of the fluid to be sprayed. Referring to the *Fluid Nozzle Orifice Size Chart*, those fluid nozzles which can be changed within an air nozzle are indicated.

Air Nozzle—Choice is determined by the type of fluid to be sprayed and the volume of air available for the gun.

—External Mix Nozzles, which are generally used, accomplish atomization outside the nozzle. Spray patterns are adjustable from round to fan with all intermediate patterns. (Designated by the letter “E”).

Siphon Type External Mix Nozzles, designated by the letter “S”, will siphon the material from a cup. Used generally for refinishing and touch-up work which does not require large quantities of paint.

Pressure Type External Mix Nozzles, designated by the letter “P”, require pressure to feed the material to the nozzle. A pressure cup, pressure tank or pump is necessary. Used for production work and where large quantities of fluid are handled. This type of nozzle has a greater range of fluid flow and does not limit the size of the paint container.

—Internal Mix Nozzles mix the air and fluid within the air nozzle. The spray pattern is determined by the shape of the nozzle and cannot be changed. Internal mix nozzles require less air and produce slightly less fog. Pressure equipment must be used

with this type of nozzle.

Recommended for maintenance spraying of heavy materials where a fine finish is not required. (Designated by the letter “T”).

C. Volume of Air (CFM required)

The cubic feet per minute (CFM) listed at 30, 50 and 70 PSI is the actual air used by the air nozzle. Increase of pressure subsequently increases volume of air required by air nozzle, or vice versa. Assume that a compressor will produce 3-5 CFM per horsepower.

NOTE

The greater the air consumption, the faster the fluid may be applied or the finer a given amount of fluid can be atomized.

COMPLETE GUN ASSEMBLIES AVAILABLE

2101-0000-0	2100 GUN LESS SET-UP
2101-2800-0	2100 GUN 63BSS LESS AIR NOZZLE
2101-2800-7	2100 GUN 63BSS-63PB (P)
2101-2808-2	2100 GUN 63BSS-66SD-3
2101-2821-3	2100 GUN 63BSS-21MD-3 (P)
2101-3100-0	2100 GUN 63CSS LESS AIR NOZZLE
2101-4300-0	2100 GUN 66SS LESS AIR NOZZLE
2101-4300-7	2100 GUN ASSEMBLY (66SS-63PB)
2101-4307-5	2100 GUN 66SS-66S (S)
2101-4307-9	2100 GUN 66SS-66SD (S)
2101-4308-2	2100 GUN 66SS-66SD-3
2101-4308-8	2100 GUN 66SS-66SK (S)
2101-4314-9	2100 GUN 66SS-200 AIR CAP
2101-4321-1	2100 GUN 66SS-21MD-1 (S)
2101-4321-2	2100 GUN 66SS-21MD-2 (S)
2101-4800-0	2100 GUN 67SS LESS AIR NOZZLE
2101-4909-5	2100 GUN 67VT-67PB (P)
2101-5100-0	2100 GUN 68SS LESS AIR NOZZLE
2101-5111-5	2100 GUN 68SS-68PB (P)
2101-5200-0	2100 GUN 68VT LESS AIR NOZZLE
2101-6260-0	2100 GUN 63SS-63P
2101-8000-0	2100 GUN 59ASS LESS AIR NOZZLE
2101-8200-0	2100 GUN 59CSS LESS AIR NOZZLE

NOZZLE SELECTION CHART

(CONTINUES ON NEXT PAGE)

TYPE OF FLUID TO BE SPRAYED	FLUID NOZZLE		ORIFICE SIZE IN [mm]	AIR NOZZLE		ADDITIONAL PARTS
VERY THIN 14–16 Sec.—No. 2 Zahn Wash Primers, Dyes, Stains, Solvents, Water, Inks	45-6301	(63SS)	.028 [0.8]	46-6000	(63P)	54-4512 BASE & RING
	45-6311	(63ASS)	.040 [1.1]	46-6000	(63P)	
	45-6321	(63BSS)	.046 [1.2]	46-6002	(63PB)	
	45-6601	(66SS)	.070 [1.8]	46-6018	(66S)	
	45-6601	(66SS)	.070 [1.8]	46-6020	(66SD)	
	45-6601	(66SS)	.070 [1.8]	46-6082	(66SK)	
VERY THIN TO MEDIUM 14–30 Secs. — No. 2 Zahn NOTE: 21MD-1 AND 21MD-2 AIR CAPS CAN SPRAY WITH PRESSURE SET-UPS PRODUCING SPRAY PATTERS APPROX. 12" WIDE.	45-6601	(66SS)	.070 [1.8]	46-21MD-1	(21MD-1)	54-4512 BASE & RING
	45-6601	(66SS)	.070 [1.8]	46-21MD-2	(21MD-2)	
	45-6701	(67SS)	.086 [2.2]	46-21MD-2	(21MD-2)	
	45-6321	(63BSS)	.046 [1.2]	46-21MD-3	(21MD-3)	
THIN 16–20 Secs. — No. 2 Zahn Sealers, Primers, Lacquers, Inks, Lubricants, Zinc Chromates, Acrylics	45-6311	(63ASS)	.040 [1.1]	46-6000	(63P)	54-4512 BASE & RING
	45-6601	(66SS)	.070 [1.8]	46-6082	(66SK)	
	45-6321	(63BSS)	.046 [1.2]	46-2200	(200)	
	45-6331	(63CSS)	.052 [1.3]			
MEDIUM 19–30 Secs. — No. 2 Zahn Lacquers, Syn. Enamels, Varnishes, Shellacs, Fillers, Primers, Epoxies, Urethanes, Lubricants, Wax Emulsions	45-6321	(63BSS)	.046 [1.2]	46-6002	(63PB)	54-4512 BASE & RING
	45-6331	(63CSS)	.052 [1.3]	46-6079	(63PR)	
	45-6601	(66SS)	.070 [1.8]	46-6020	(66SD)	
	45-6601	(66SS)	.070 [1.8]	46-6082	(66SK)	
	45-6331	(63CSS)	.052 [1.3]	46-2200	(200)	
	45-6601	(66SS)	.070 [1.8]			
HIGH SOLIDS Enamels	45-6601	(66SS)	.070 [1.8]	46-6079	(63PR)	
HEAVY (CREAM-LIKE) Over 28 Secs. — No. 4 Ford House Paint, Wall Paint (Oil, Latex), Block Sealers, Mill Whites, Vinyls, Acrylics, Epoxies, Gel Coats	45-6701	(67SS)	.086 [2.2]	46-6026	(67PB)	
	45-6801	(68SS)	.110 [2.8]	46-6032	(68PB)	
VERY HEAVY Unaggregated, Block Fillers, Textured Coatings, Fire Retardants, Road Marking Paint, Bitumastics, Cellular Plastics, Underbody, Roof Coatings	45-6801	(68SS)	.110 [2.8]	46-6032	(68PB)	54-2065 RING 54-2065 RING 54-2065 RING 54-2065 RING
	45-5911	(59ASS)	.171 [4.3]	46-2244	(244)	
	45-5912	(59BSS)	.218 [5.5]	46-2250	(250)	
	45-5912	(59BSS)	.218 [5.5]	46-2252	(252)	
	45-5913	(59CSS)	.281 [7.1]	46-2262	(262)	
ADHESIVES Waterbase — White Vinyl Glue Solvent Base — Neoprenes (Contact Cements)	45-6331	(63CSS)	.052 [1.3]	46-6002	(63PB)	54-4512 BASE & RING
	45-6601	(66SS)	.070 [1.8]	46-6079	(63PR)	
	45-6701	(67SS)	.086 [2.2]	46-6026	(67PB)	
	45-6301	(63SS)	.028 [0.8]	46-6092	(66SD-3)	
	45-6311	(63ASS)	.040 [1.1]	46-6092	(66SD-3)	
	45-6321	(63BSS)	.046 [1.2]	46-6092	(66SD-3)	
	45-6601	(66SS)	.070 [1.8]	46-6092	(66SD-3)	
	45-6601	(66SS)	.070 [1.8]	46-6103	(66SDJG)	
	45-6601	(66SS)	.070 [1.8]	46-6041	(66R)	
	45-6601	(66SS)	.070 [1.8]	46-6103	(66SDJG)	
	45-6605	(L6SS)	.070 [1.8]	46-6061	(63PH-1)	
CERAMICS & SIMILAR ABRASIVE MATERIALS Glazes, Engobes, Porcelain Enamel	45-6402	(64VT)	.064 [1.6]	46-6007	(64PA)	54-4512 BASE & RING
	45-6702	(67VT)	.086 [2.2]	46-6028	(67PD)	
	45-6802	(68VT)	.110 [2.8]	46-6032	(68PB)	
CONCRETE CURING COMPOUNDS	45-6601	(66SS)	.070 [1.8]	46-2200	(200)	54-4512 BASE & RING
MULTICOLOR PAINTS	45-6601	(66SS)	.070 [1.8]	46-2200	(200)	54-4512 BASE & RING
	45-6801	(68SS)	.110 [2.8]	46-2201	(201)	54-4512 BASE & RING
	45-6801	(68SS)	.110 [2.8]	46-2205	(206)	54-4512 BASE & RING
NON-STICK COATINGS	45-6311	(63ASS)	.040 [1.1]	46-6002	(63PB)	54-4512 BASE & RING
	45-6321	(63BSS)	.046 [1.2]	46-6079	(63PR)	
	45-6601	(66SS)	.070 [1.8]	46-6020	(66SD)	
HAMMERS	45-6331	(63CSS)	.052 [1.3]	46-6002	(63PB)	54-4512 BASE & RING
	45-6601	(66SS)	.070 [1.8]	46-6002	(63PB)	
	45-6601	(66SS)	.070 [1.8]	46-6020	(66SD)	
WRINKLE ENAMELS	45-6331	(63CSS)	.052 [1.3]	46-6002	(63PB)	54-4512 BASE & RING
	45-6601	(66SS)	.070 [1.8]	46-6002	(63PB)	
ZINC RICH COATINGS	45-6702	(67VT)	.086 [2.2]	46-6026	(67PB)	

(CONTINUED FROM PREVIOUS PAGE)

NOZZLE SELECTION CHART

TYPE OF FLUID TO BE SPRAYED	FLUID NEEDLE NO. ★		TYPE*	CFM [L/m] @						PATTERN @ 8 IN [203 mm]	
				30 PSI [2.1 BAR]		50 PSI [3.4 BAR]		70 PSI [4.8 BAR]		IN	[mm]
VERY THIN 14–16 Sec.—No. 2 Zahn Wash Primers, Dyes, Stains, Solvents, Water, Inks	47-56300	(563)	PE	4.5	[127.4]	7.5	[212.3]	10.0	[283.1]	5.0	[127.0]
	47-56310	(563A)	PE	5.1	[144.4]	8.7	[246.3]	12.2	[345.4]	11.0	[279.4]
	47-56310	(563A)	PE	9.0	[254.8]	14.3	[404.9]	20.0	[566.3]	14.0	[355.6]
	47-56500	(565)	SE	3.4	[96.27]	5.0	[141.5]			9.0	[228.6]
	47-56500	(565)	SE	7.9	[223.7]	12.1	[342.6]			10.5	[266.7]
	47-56500	(565)	SE	11.0	[311.4]	15.2	[430.4]	19.5	[552.1]	13.0	[330.2]
	47-56310	(563A)	PI	3.1	[87.78]	5.2	[147.2]	6.4	[181.2]	12.0	[304.8]
VERY THIN TO MEDIUM 14–30 Secs. — No. 2 Zahn NOTE: 21MD-1 AND 21MD-2 AIR CAPS CAN SPRAY WITH PRESSURE SET-UPS PRODUCING SPRAY PATTERNS APPROX. 12" WIDE.	47-56500	(565)	SE	12.0	[339.8]	17.3	[489.8]	23.0	[651.2]	11.0	[279.4]
	47-56500	(565)	SE	15.2	[430.4]	22.2	[628.6]	29.6	[838.1]	11.0	[279.4]
	47-56700	(567)	SE	12.5	[353.9]	18.3	[518.1]	24.4	[690.9]	13.0	[330.2]
	47-56310	(563A)	PE	11.6	[328.4]	16.6	[470.0]	22.2	[628.6]	16.0	[406.4]
THIN 16–20 Secs. — No. 2 Zahn Sealers, Primers, Lacquers, Inks, Lubricants, Zinc Chromates, Acrylics	47-56310	(563A)	PE	5.1	[144.4]	8.7	[246.3]	12.2	[345.4]	11.0	[279.4]
	47-56500	(565)	SE	11.0	[311.4]	15.2	[430.4]	19.5	[552.1]	13.0	[330.2]
	47-56310	(563A)	PI	3.1	[87.78]	5.2	[147.2]	6.4	[181.2]	12.0	[304.8]
	47-56310	(563A)	PI	3.9	[110.4]	5.5	[155.7]	7.4	[209.5]	9.0	[228.6]
MEDIUM 19–30 Secs. — No. 2 Zahn Lacquers, Syn. Enamels, Varnishes, Shellacs, Fillers, Primers, Epoxies, Urethanes, Lubricants, Wax Emulsions	47-56310	(563A)	PE	9.0	[254.8]	14.3	[404.9]	20.0	[566.3]	14.0	[355.6]
	47-56310	(563A)	PE	9.5	[269.0]	15.5	[438.9]	19.5	[552.1]	18.0	[457.2]
	47-56500	(565)	SE	7.9	[223.7]	12.0	[339.8]			11.0	[279.4]
	47-56500	(565)	SE	11.0	[311.4]	15.2	[430.4]	19.5	[552.1]	13.0	[330.2]
	47-56310	(563A)	PI	3.1	[87.78]	5.2	[147.2]	6.4	[181.2]	12.0	[304.8]
	47-56500	(565)	PI	3.9	[110.4]	5.5	[155.7]	7.4	[209.5]	9.0	[228.6]
HIGH SOLIDS Enamels	47-56500	(565)	PE	9.5	[269.0]	15.5	[438.9]	19.5	[552.1]	18.0	[457.2]
HEAVY (CREAM-LIKE) Over 28 Secs. — No. 4 Ford House Paint, Wall Paint (Oil, Latex), Block Sealers, Mill Whites, Vinyls, Acrylics, Epoxies, Gel Coats	47-56700	(567)	PE	9.5	[269.0]	14.9	[421.9]	19.5	[552.1]	12.0	[304.8]
	47-56800	(568)	PE	9.5	[269.0]	14.1	[399.2]	19.1	[540.8]	12.0	[304.8]
VERY HEAVY Unaggregated, Block Fillers, Textured Coatings, Fire Retardants, Road Marking Paint, Bitumastics, Cellular Plastisols, Underbody, Roof Coatings	47-56800	(568)	PE	9.5	[269.0]	14.1	[399.2]	19.1	[540.8]	12.0	[304.8]
	47-55900	(559)	PI	7.8	[220.8]	11.5	[325.6]	15.2	[430.4]	12.0	[304.8]
	47-55900	(559)	PI	7.3	[206.7]	11.0	[311.4]	14.7	[416.2]	Round	
	47-55900	(559)	PI	7.8	[220.8]	11.5	[325.6]	15.2	[430.4]	6.0	[152.4]
	47-55900	(559)	PI	7.3	[206.7]	11.0	[311.4]	14.7	[416.2]	6.0	[152.4]
ADHESIVES Waterbase — White Vinyl Glue Solvent Base — Neoprenes (Contact Cements)	47-56310	(563A)	PE	9.0	[254.8]	14.3	[404.9]	20.0	[566.3]	14.0	[355.6]
	47-56500	(565)	PE	9.5	[269.0]	15.5	[438.9]	19.5	[552.1]	15.0	[381.0]
	47-56700	(567)	PE	9.5	[269.0]	14.1	[399.2]	19.1	[540.8]	12.0	[304.8]
	47-56300	(563)	PE	10.4	[294.4]	15.4	[436.0]	20.4	[577.6]	9.0	[228.6]
	47-56310	(563A)	PE	10.4	[294.4]	15.4	[436.0]	20.4	[577.6]	9.0	[228.6]
	47-56310	(563A)	PE	10.4	[294.4]	15.4	[436.0]	20.4	[577.6]	11.0	[279.4]
	47-56500	(565)	PE	14.2	[402.0]	21.2	[600.3]	20.4	[577.6]	10.0	[254.0]
	47-56500	(565)	PE	10.4	[294.4]					9.0	[228.6]
	47-56500	(565)	PE / SE			4.2	[118.9]			Round	
	47-56500	(565)	PE	10.4	[294.4]					9.0	[228.6]
47-56500	(565)	PE	9.5	[269.0]	14.2	[402.0]	19.0	[538.0]	18.0	[457.2]	
CERAMICS & SIMILAR ABRASIVE MATERIALS Glazes, Engobes, Porcelain Enamel	47-57402	(574VT)	PE	12.1	[342.6]	15.0	[424.7]	21.0	[594.6]	13.0	[330.2]
	47-57702	(577VT)	PE	10.0	[283.1]	15.0	[424.7]	20.0	[566.3]	15.0	[381.0]
	47-57802	(578VT)	PE	9.5	[269.0]	14.1	[399.2]	19.1	[540.8]	12.0	[304.8]
CONCRETE CURING COMPOUNDS	47-56500	(565)	PI	3.1	[87.78]	5.2	[147.2]	6.4	[181.2]	15.0	[381.0]
MULTICOLOR PAINTS	47-56500	(565)	PI	3.1	[87.78]	5.2	[147.2]			15.0	[381.0]
	47-56800	(568)	PI			6.8	[192.5]			11.0	[279.4]
	47-56800	(568)	PI			9.8	[277.5]			15.0	[381.0]
NON-STICK COATINGS	47-56310	(563A)	PE	9.0	[254.8]	14.3	[404.9]	20.0	[566.3]	10.0	[254.0]
	47-56310	(563A)	PE	9.5	[269.0]	15.5	[438.9]	19.5	[552.1]	15.0	[381.0]
	47-56500	(565)	SE	7.9	[223.7]	12.1	[342.6]			7.0	[177.8]
HAMMERS	47-56310	(563A)	PE	9.0	[254.8]	14.3	[404.9]			14.0	[355.6]
	47-56500	(565)	PE	9.0	[254.8]	14.3	[404.9]			14.0	[355.6]
	47-56500	(565)	SE	7.9	[223.7]	12.1	[342.6]			7.0	[177.8]
WRINKLE ENAMELS	47-56310	(563A)	PE	9.0	[254.8]	14.3	[404.9]	20.0	[566.3]	10.0	[254.0]
	47-56500	(565)	PE	9.0	[254.8]	14.3	[404.9]	20.0	[566.3]	10.0	[254.0]
ZINC RICH COATINGS	47-57702	(577VT)	PE	9.5	[269.0]	14.1	[399.2]	19.1	[540.8]	12.0	[304.8]

All air nozzles shown in combination with these (+) fluid nozzles can also be used in combination with any other fluid nozzle marked (+)

*See text Section B, page 8, for type code. ★All standard needles listed are stainless steel.

SPECIAL NOZZLES – INTERNAL MIX HEAVY MATERIAL

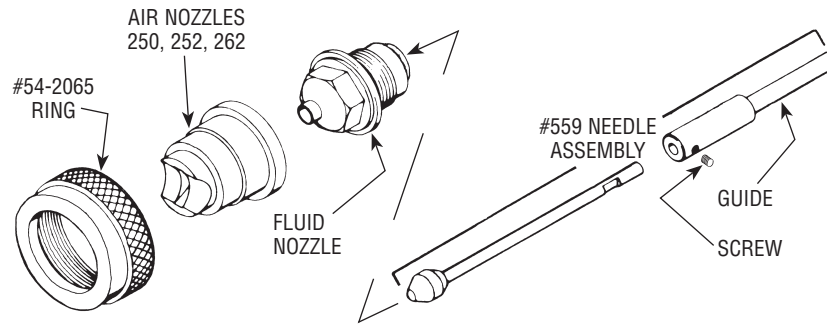

SPECIAL NOZZLES – INTERNAL MIX HEAVY MATERIAL

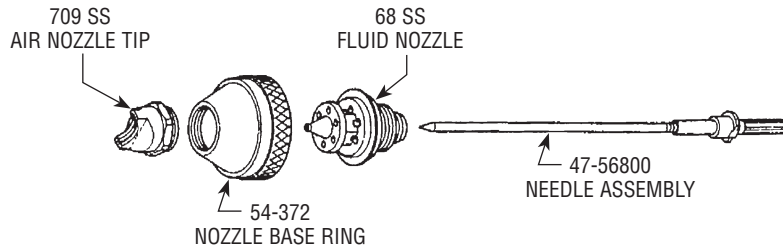

MULTI-COLOR CONVERSION KIT FOR 60 SERIES NOZZLES & 200 SERIES TIPS

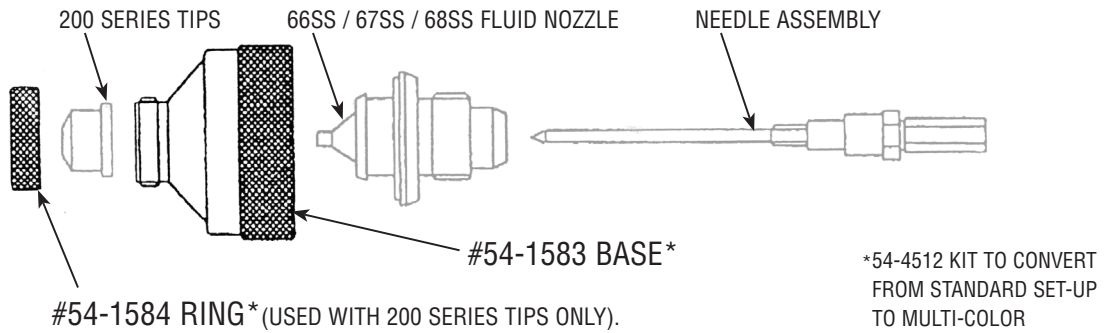

SPECIAL NOZZLE – CLEANING

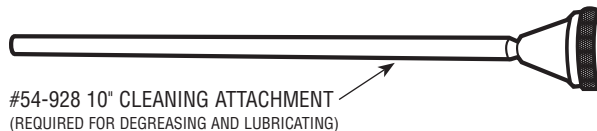

ACCESSORIES

HAF-507 Whirlwind™ In-Line Air Filter Kit of 12

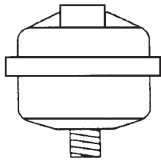

Removes water, oil, and debris from the air line.

192212 Professional Spray Gun Cleaning Kit



Contains six precision tools designed to effectively clean all DeVilbiss, Binks, Finishline and other brand spray guns.

6-429 Binks Gunners Mate Lube (Twenty 2 oz. bottles)



Compatible with all paint materials; contains no silicone or petroleum distillates to contaminate paint. SDS available upon request.

HAV-500 OR HAV-501 Adjusting Valve (HAV-501 SHOWN)

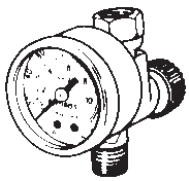

HAV-500 does not have pressure gauge. Use to control air usage at gun.

Millennium 3000 Twin Cartridge Paint Spray Respirator



NIOSH-Certified, for respiratory protection in atmospheres not immediately dangerous to life.

Small 40-141	Medium 40-128	Large 40-143
-----------------	------------------	-----------------

29-3100 Scrubs™ Hand Cleaner Towels







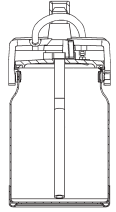





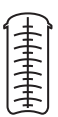
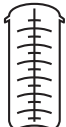
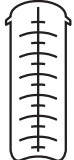



Scrubs™ are a premoistened hand cleaner towel for painters, body men and mechanics that go where you go and no water is needed.

TGC-545 1 Qt. Siphon Cup (Aluminum)



3/8" nps thread for full size guns.

DeKups® Accessories for siphon feed cups

 DPC-60-K10 9oz Universal x10	 DPC-59-K10 24oz Universal x10	 DPC-61-K10 34oz Universal x10	 125 µm DPC-42-K24 x24	 200 µm DPC-66-K24 x24	 DPC-6-K10 x10
 DPC-607 x2	 DPC-606 x2	 DPC-608 x2	 125 µm DPC-65-K24 x24	 200 µm DPC-67-K24 x24	 DPC-22-K24 x24
SHELLS			 9 FL 265 mL DPC-602 x32	 24 FL 710 mL DPC-601 x32	 34 FL 1000 mL DPC-600 x32
			LINERS		
 DPC-44					
 DPC-69-K1 3/8 NPS Siphon Cup Adapter Kit					

NOTES

NOTES

WARRANTY POLICY

This product is covered by Carlisle Fluid Technologies' materials and workmanship limited warranty. The use of any parts or accessories, from a source other than Carlisle Fluid Technologies, will void all warranties. Failure to reasonably follow any maintenance guidance provided may invalidate any warranty.

For specific warranty information please contact Carlisle Fluid Technologies.

Carlisle Fluid Technologies is a global leader in innovative finishing technologies. Carlisle Fluid Technologies reserves the right to modify equipment specifications without prior notice.

DeVilbiss®, Ransburg®, ms®, BGK®, and Binks®
are registered trademarks of Carlisle Fluid Technologies, Inc.

©2019 Carlisle Fluid Technologies, Inc.
All rights reserved.

For technical assistance or to locate an authorized distributor,
contact one of our international sales and customer support locations.

Region	Industrial / Automotive	Automotive Refinishing
Americas	Tel: 1-800-992-4657 Fax: 1-888-246-5732	Tel: 1-800-445-3988 Fax: 1-800-445-6643
Europe, Africa, Middle East, India	Tel: +44 (0)1202 571 111 Fax: +44 (0)1202 573 488	
China	Tel: +8621-3373 0108 Fax: +8621-3373 0308	
Japan	Tel: +81 45 785 6421 Fax: +81 45 785 6517	
Australia	Tel: +61 (0) 2 8525 7555 Fax: +61 (0) 2 8525 7575	

For the latest information about our products, visit www.carlisleleft.com